

DOORSNEDE 1
WOONRUUFFASE
SCHAAL 1:50

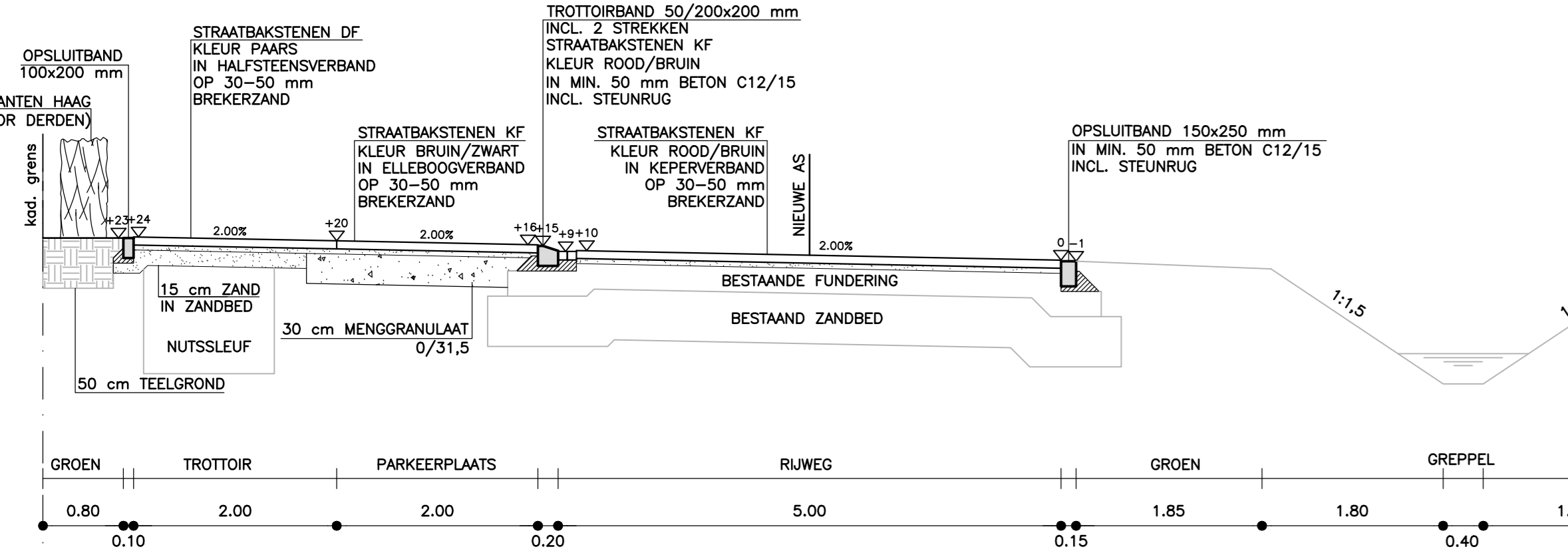

DOORSNEDE 2
WOONRUUFFASE
SCHAAL 1:50

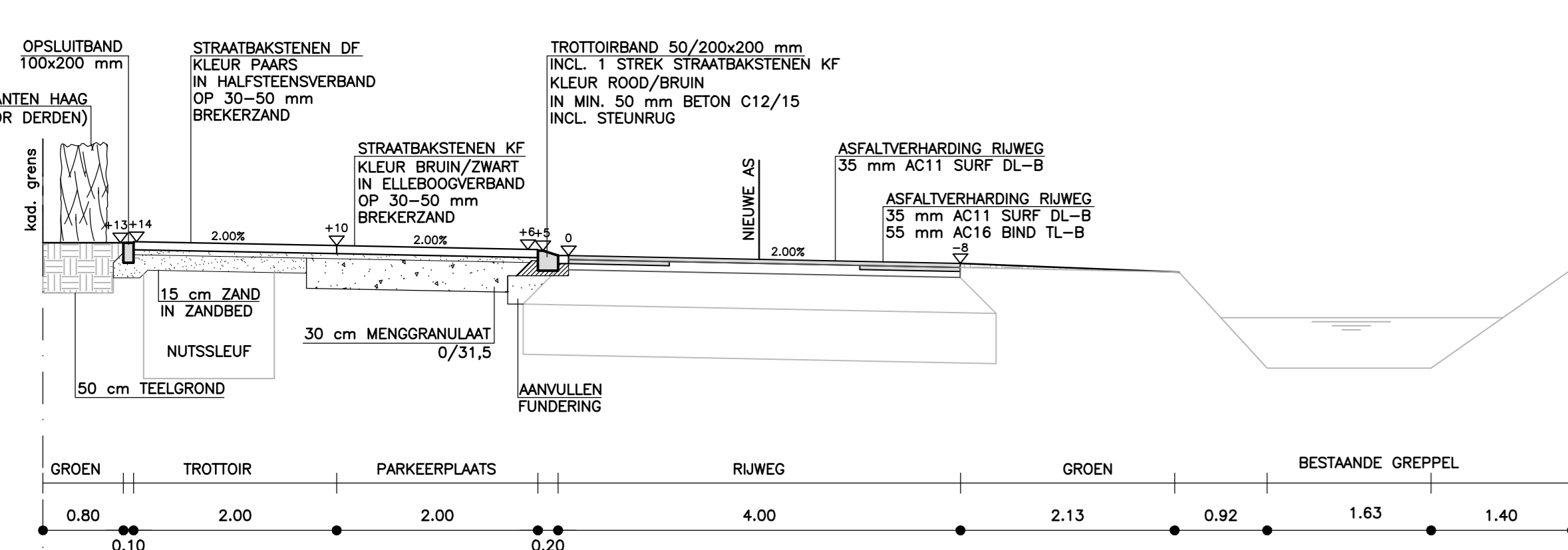

DOORSNEDE 3
WOONRUUFFASE - KRUISVAKKER
SCHAAL 1:50

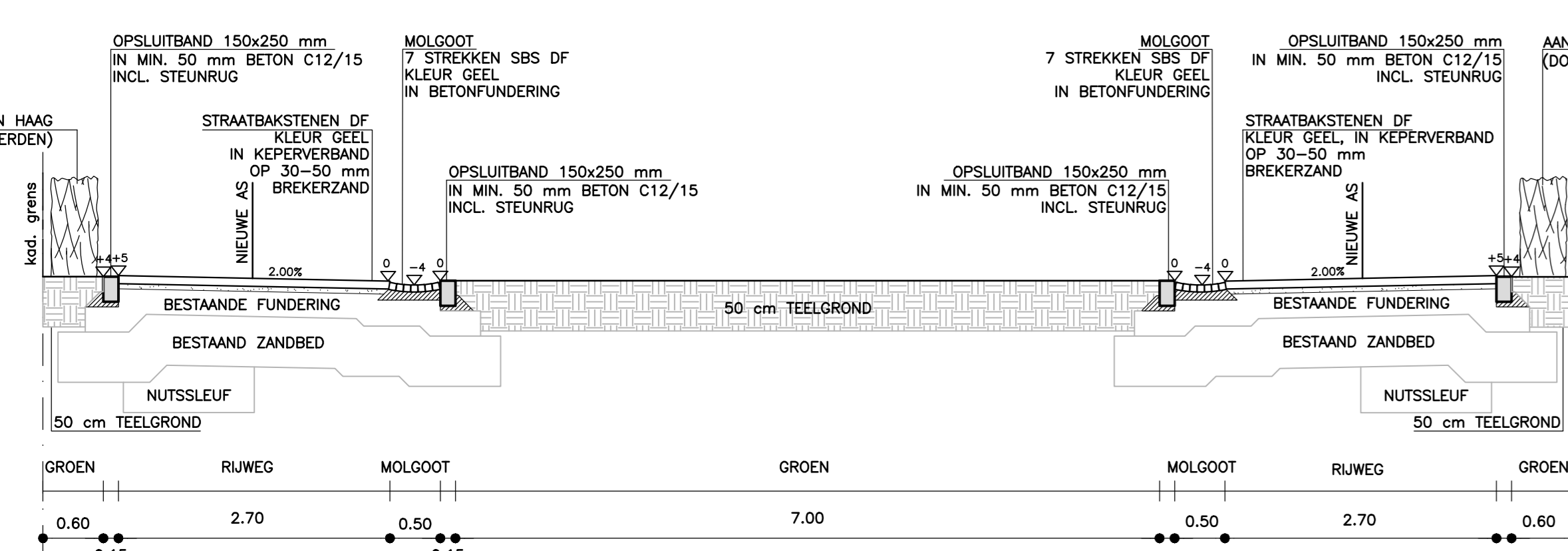

DOORSNEDE 4
WOONRUUFFASE - HOFJES
SCHAAL 1:50

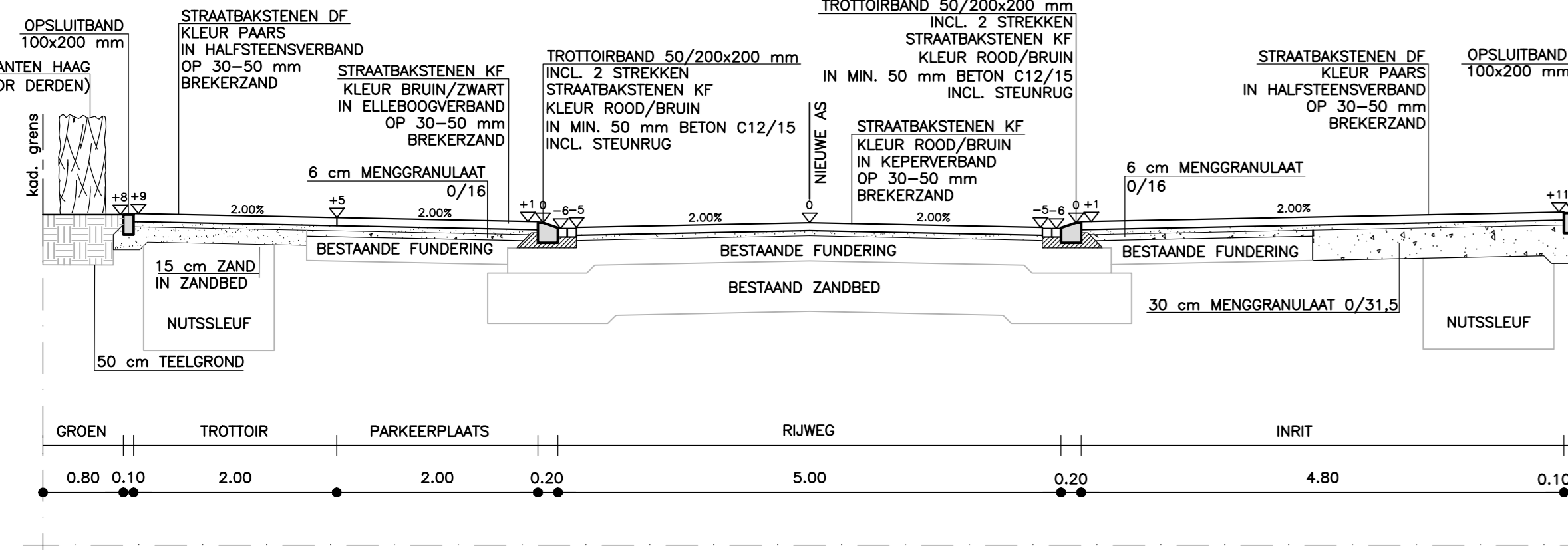

DOORSNEDE 5
WOONRUUFFASE
SCHAAL 1:50

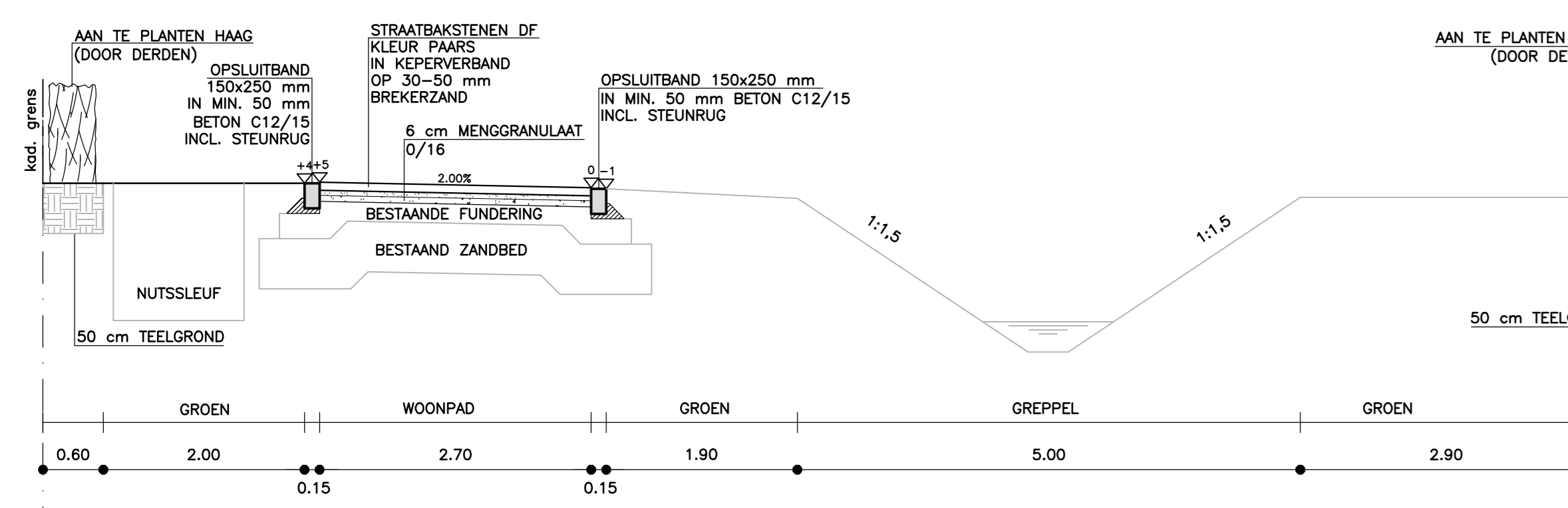

DOORSNEDE 6
WOONRUUFFASE
SCHAAL 1:50

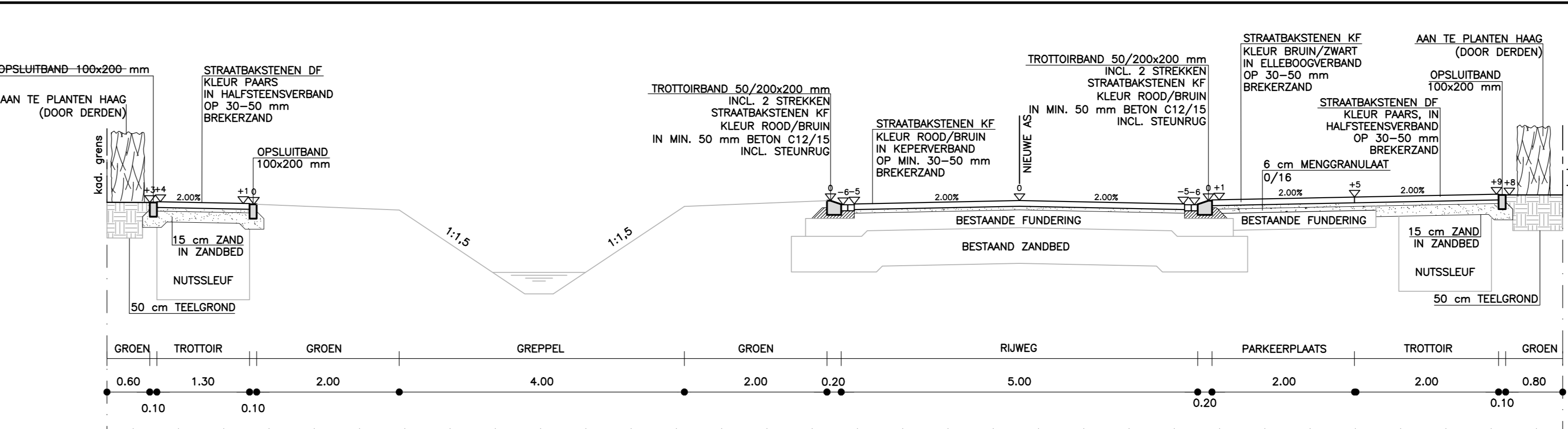

DOORSNEDE 7
WOONRUUFFASE
SCHAAL 1:50

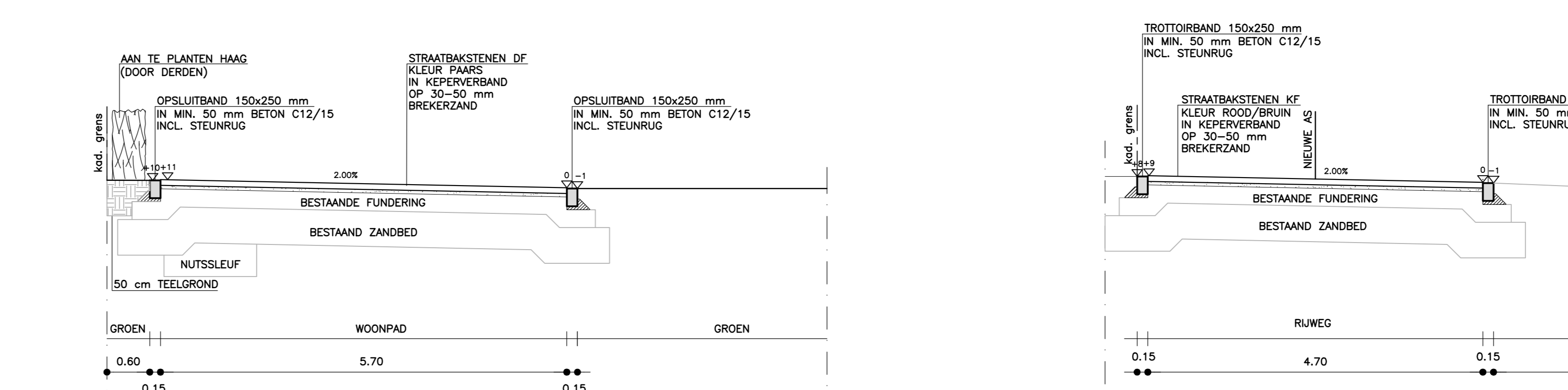

DOORSNEDE 8
WOONRUUFFASE
SCHAAL 1:50

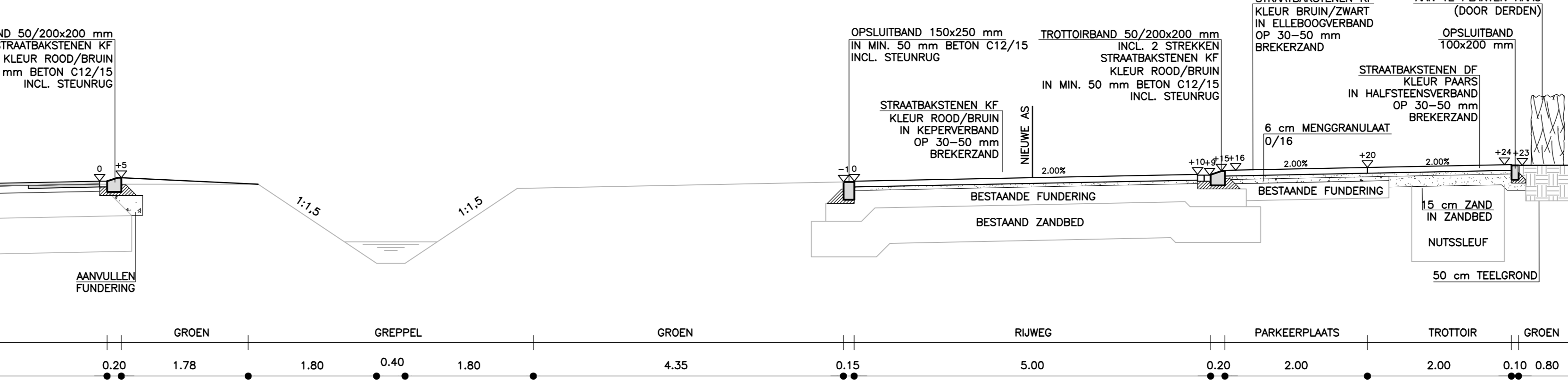

DOORSNEDE 9
WOONRUUFFASE
SCHAAL 1:50

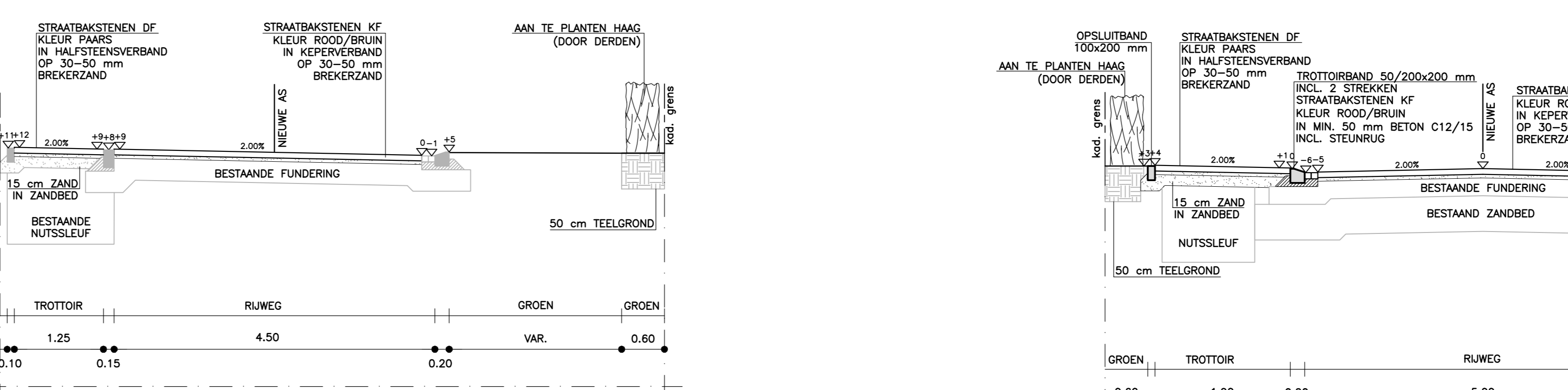

DOORSNEDE 10
WOONRUUFFASE - MAASWEG
SCHAAL 1:50

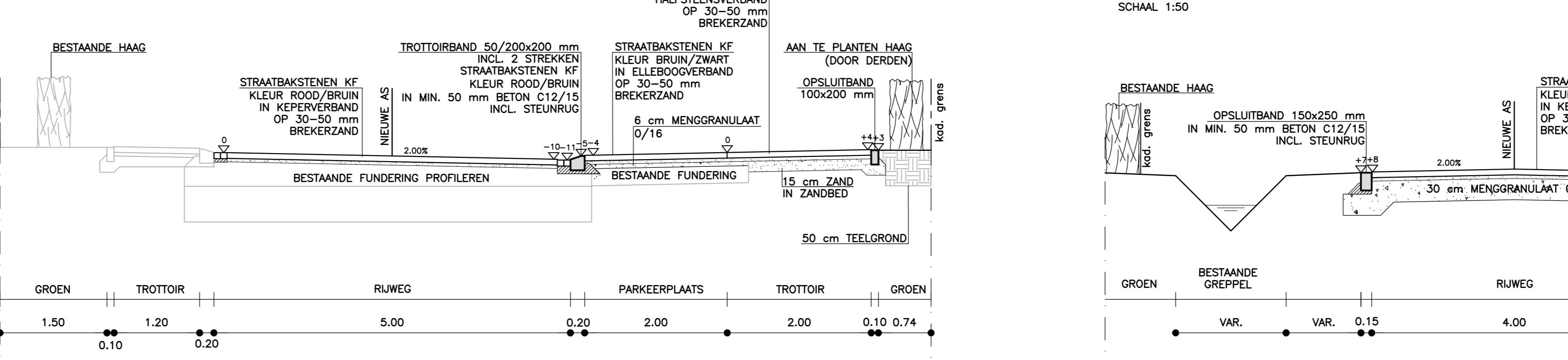

DOORSNEDE 11
WOONRUUFFASE - KORENVAAR
SCHAAL 1:50

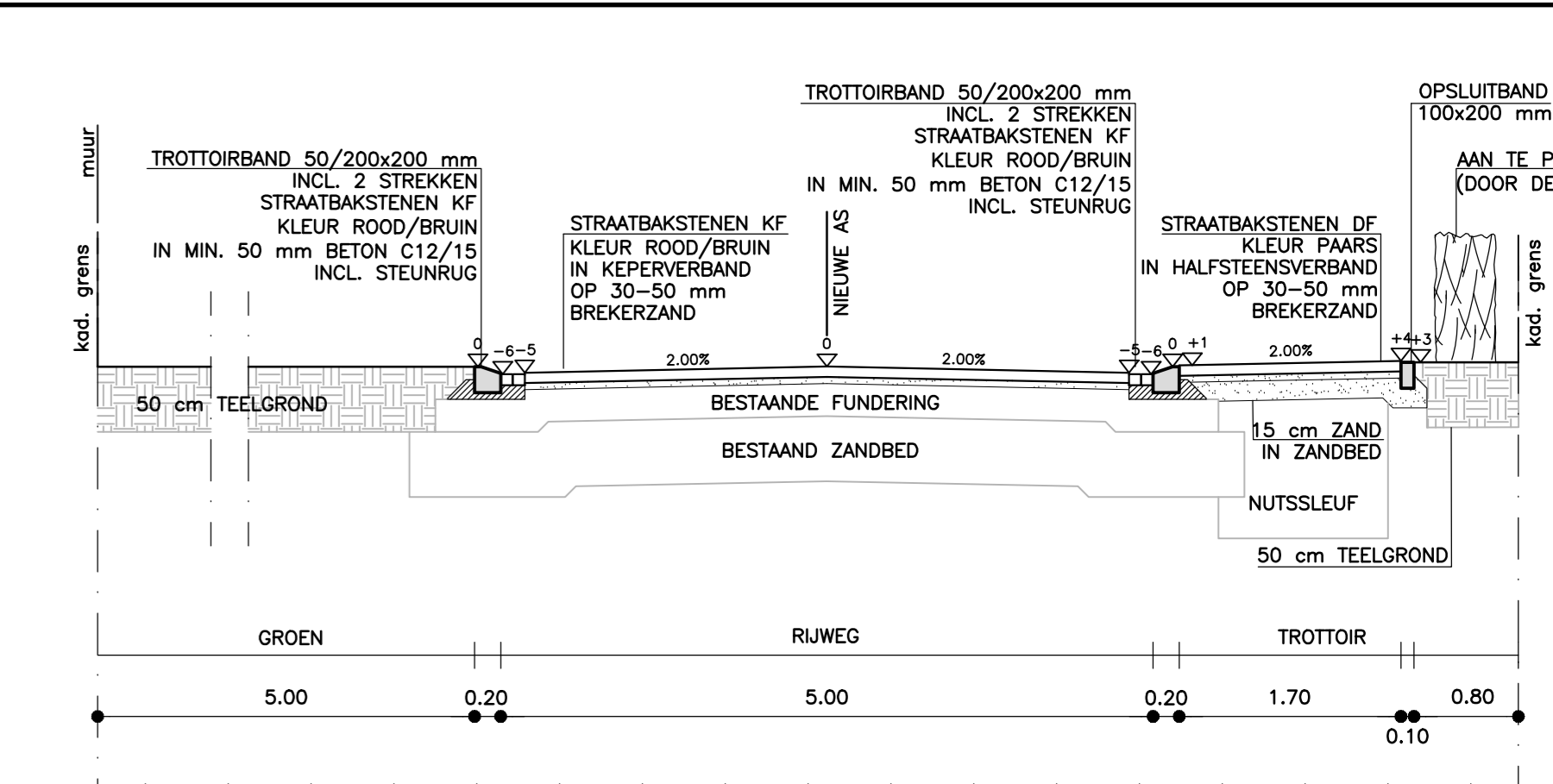

DOORSNEDE 12
WOONRUUFFASE
SCHAAL 1:50

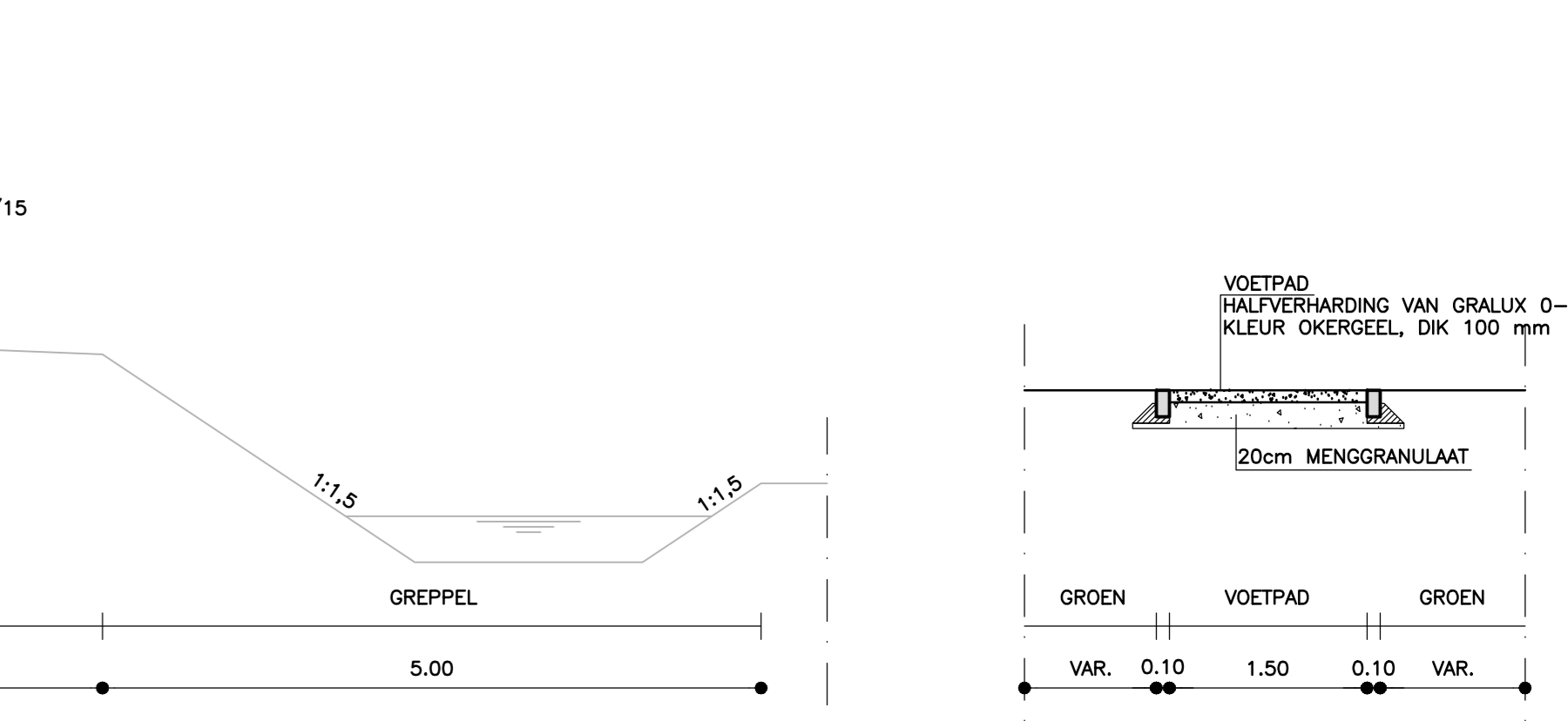

DOORSNEDE 13
FIETSPAD - WOONRUUFFASE
SCHAAL 1:50

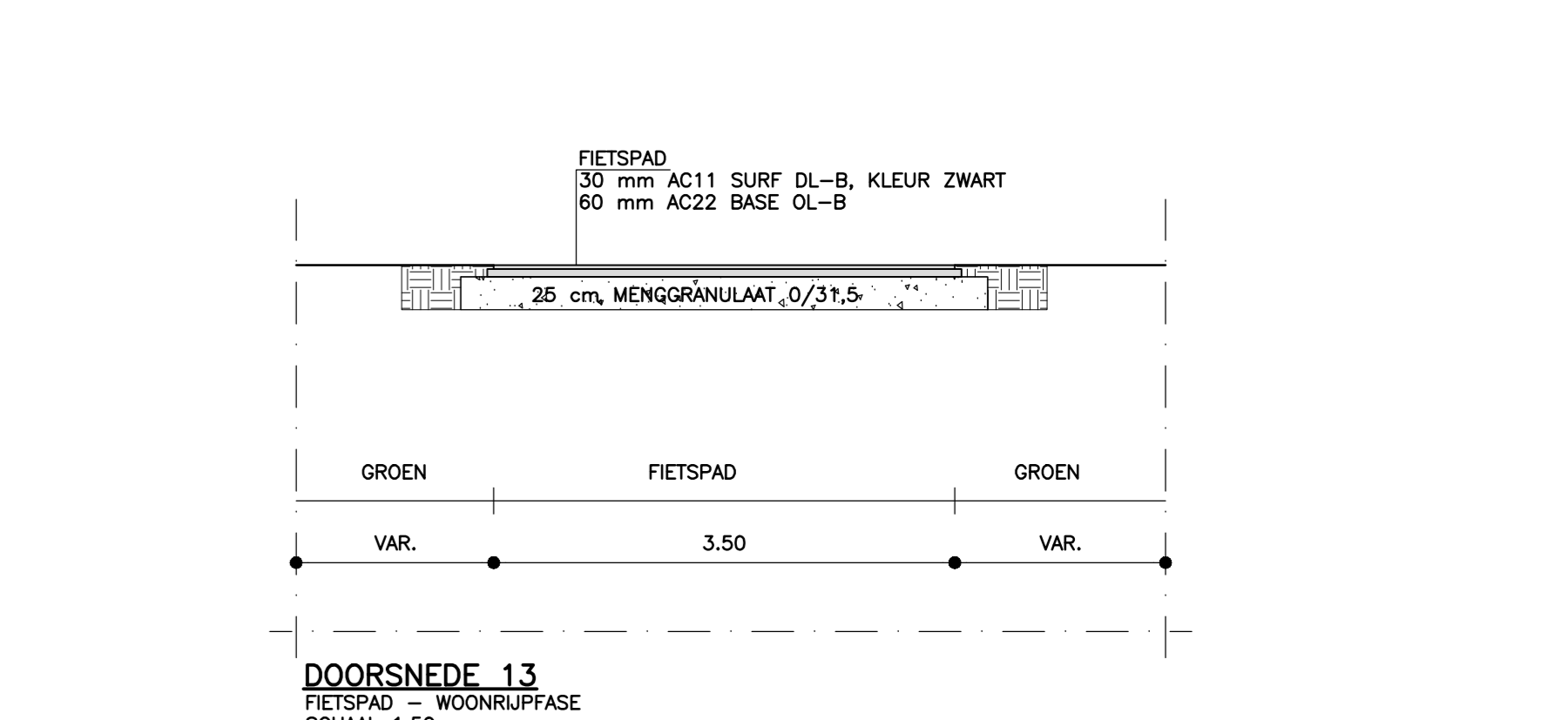

DOORSNEDE 14
WOONRUUFFASE
SCHAAL 1:50

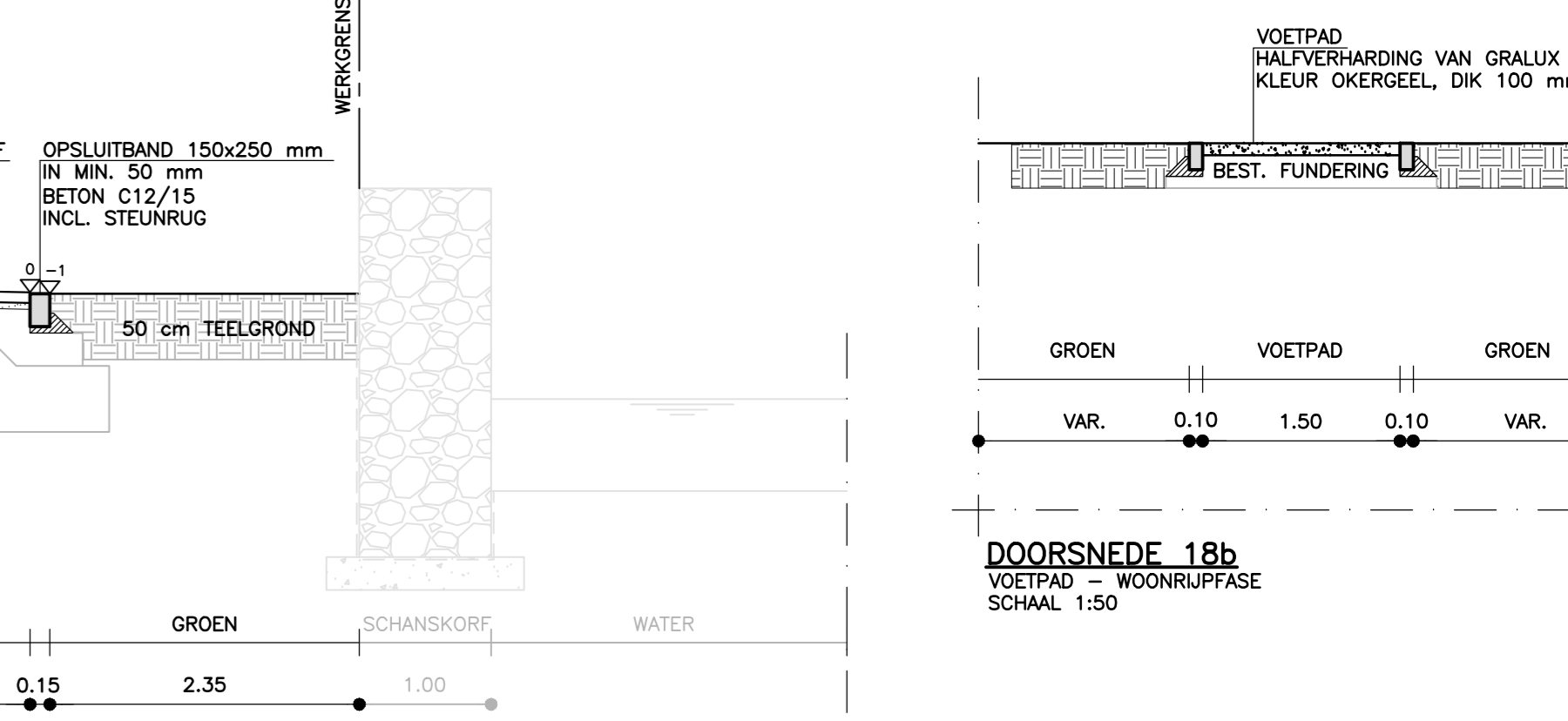

DOORSNEDE 15
WOONRUUFFASE
SCHAAL 1:50

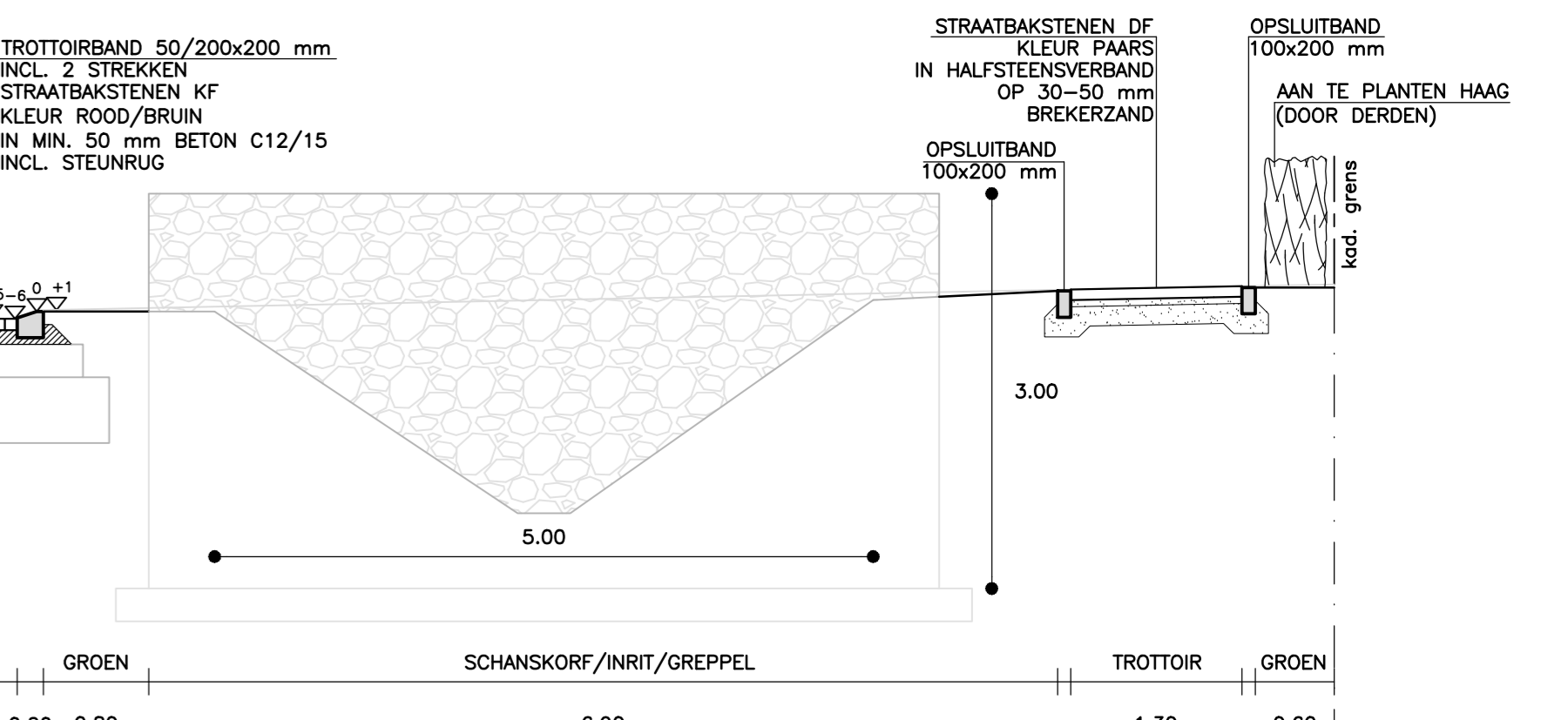

DOORSNEDE 16
WOONRUUFFASE
SCHAAL 1:50

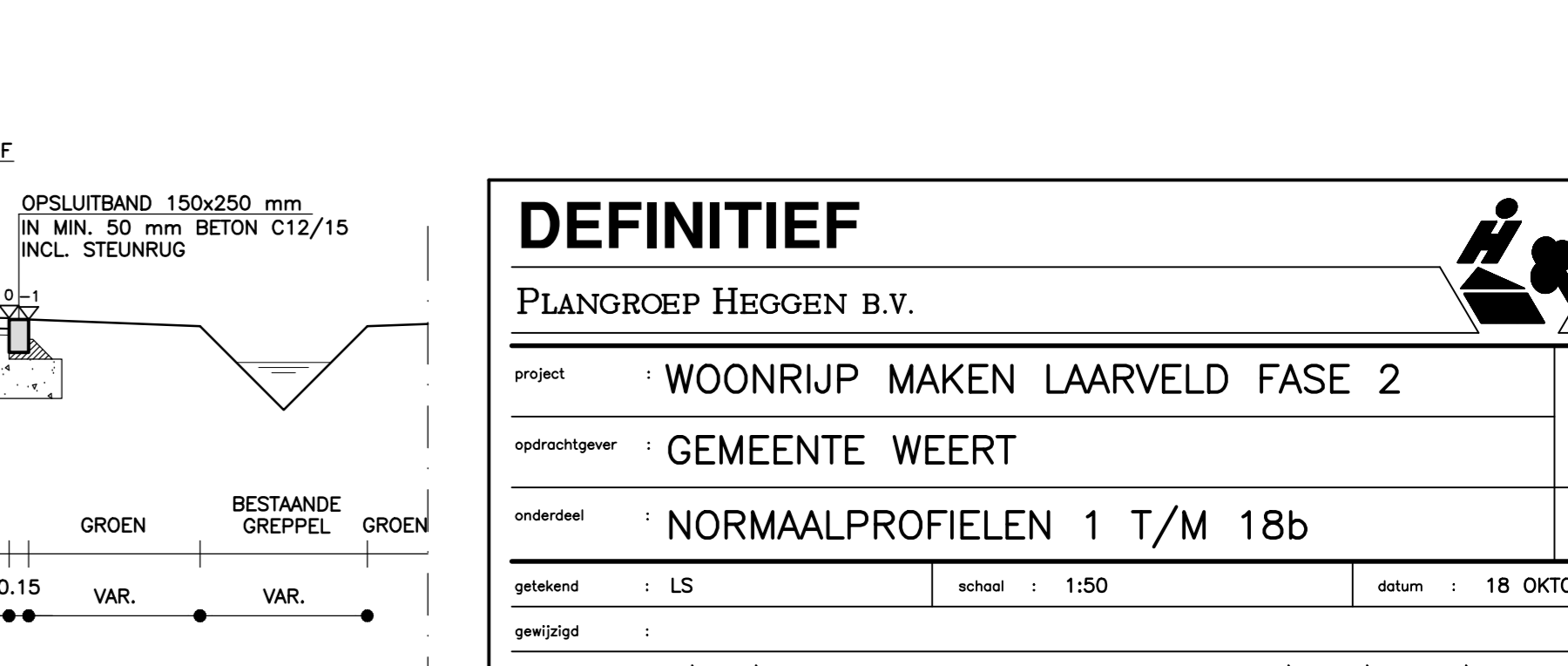

DOORSNEDE 17
WOONRUUFFASE - ST. DONATUSKAPELSTRAAT
SCHAAL 1:50

DEFINITIEF

PLANGROEP HEGGEN B.V.

project : WOONRIJP MAKEN LAARVELD FASE 2 18.085

opdrachtgever : GEMEENTE WEERT

ordercode : NORMAALPROFIELEN 1 T/M 18b B.11

getekend : LS schaal : 1:50 datum : 18 OKTOBER 2019

getekend : gsm

gsm-beoordeld : G:\2018\18.085 - Woonrijp maken Laarveld fase 2, Weert\Bestel\Definitief\18.085 - NPROF.dwg

Projectnaam : 18.085 - Woonrijp maken Laarveld fase 2, Weert\Bestel\Definitief\18.085 - NPROF.dwg

Projectnaam : 18.085 - Woonrijp maken Laarveld fase 2, Weert\Bestel\Definitief\18.085 - NPROF.dwg

Projectnaam : 18.085 - Woonrijp maken Laarveld fase 2, Weert\Bestel\Definitief\18.085 - NPROF.dwg